

### Product Dimensions

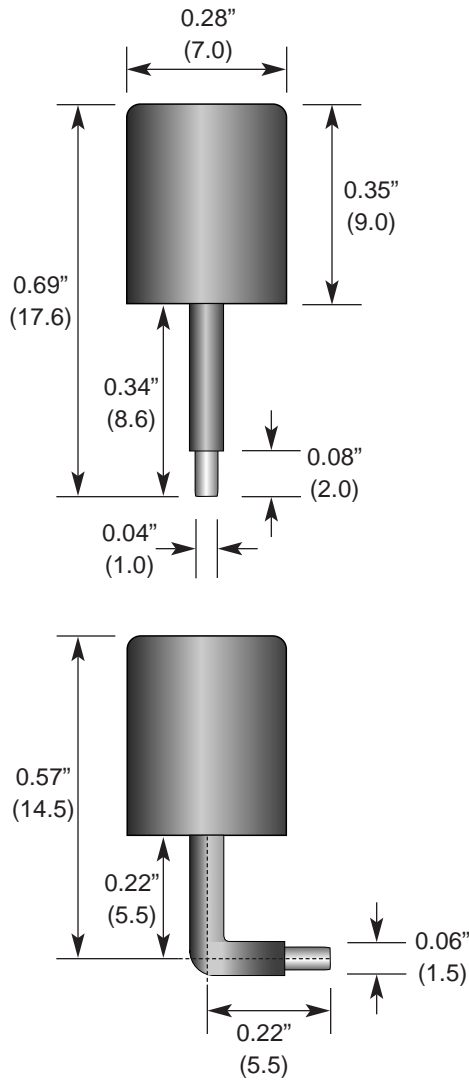

### Description



The JJB Series packs near the performance of a conventional monopole into an incredibly compact quarter-inch (7mm) diameter package. These antennas are ideal for any OEM application requiring a compact, cosmetically-attractive, low-cost antenna solution. The antenna features a through-hole feedline that can attach directly to a user's PCB. Internal or external mounting is possible.

### Features

- Very low cost
  - Ultra-compact package
  - Easily concealed internally
  - Good for internal or external mounting
  - Excellent performance
  - Omni-directional pattern
  - Use with plastic\* or metal enclosures
- \* Requires proximity ground plane

### Electrical Specifications

- Center Freq. 868MHz
- Bandwidth 25MHz
- Wavelength 1/4-wave
- VSWR  $\leq 2.0$  typ. at center
- Impedance 50 ohms
- Connection Direct solder

RA electrical specifications and plots measured on a 1.50" x 3.30" ground plane  
ST electrical specifications and plots measured on a 3.50" x 3.50" ground plane

### Ordering Information

- ANT-868-JJB-RA (Right-Angle)
- ANT-868-JJB-ST (Straight)

### Recommended Mounting

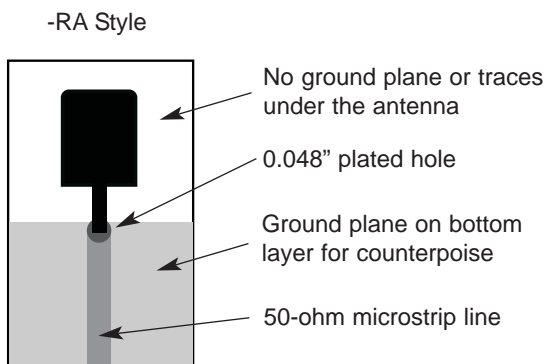

### VSWR Graph

